

MUNDIAL

INDUSTRIAL PLUGS AND SOCKETS

Description: IP44 WANDER SOCKET 2P+E 220V 32A 6H

Reference:

02204

Characteristics:

Product type:	Low voltage wander socket
Current:	32A
Poles:	2P+E
Voltage:	200/250 V
Frecuency(Hz):	-
Time code:	6
Colour:	Blue
Weight (kg):	1,77
Dimensions:	
Materials:	Halogen-free plastic materials. Plastic parts: polyamide 6. Contacts: copper-zinc alloy
Packaging units:	8

Technical data:

Degree of protection:	IP44
Degree of protection remarks:	
Resistance to impact:	IK08
Glow wire resistance:	960 °C
Ball pressure test:	125 °C
Ambient temperature range:	-25 °C / +40 °C

Certifications and norms:

Directive:	2014/35/EU
Standards:	IEC 60309-1-2
Certificates:	



Codes:

EAN:	8431044022048
Customs tariff number:	85.36.69.90
ETIM 8.0:	EC001320

MUNDIAL

INDUSTRIAL PLUGS AND SOCKETS

Description: IP44 WANDER SOCKET 2P+E 220V 32A 6H

Reference: 02204

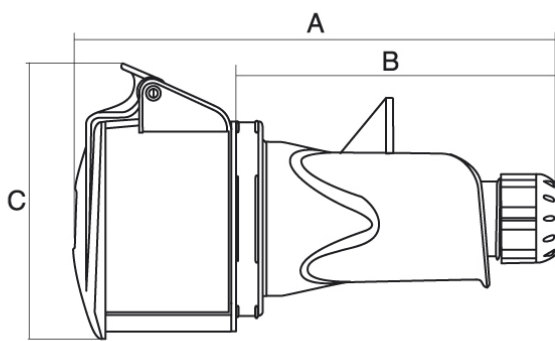

Dimensions:

I	Poles	Dimensions		
		A	B	C
16 A	2P+E	151	96	82
	3P+E	156	106	86
	3P+N+E	161	111	98
32A	2P+E	171	111	98
	3P+E	171	111	98
	3P+N+E	178	118	102

Sustainability:

RoHS - REACH

Product end of life stage:

Product concerned in the WEEE regulations.

Supply:

Supplied in a single box per packaging multiple